

Compact S

800W LED High Mast Light Specification

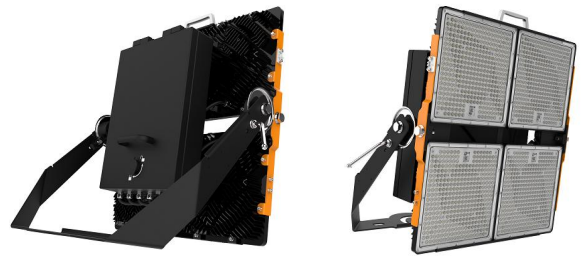

Parameters

Product Model	YHL-PO2-800
LED Chip Brand	Nichia
Light Efficiency	130 lm/W
Luminous Flux	104000 lm
Color Temperature	4500 ~ 5500K(2500 ~ 5500K optional)
Beam Angle	30°(60°、20° optional)
Total Power Consumption	800W±20W
Output Current	3.9A (constant current)*4
Output Voltage	DC 40 ~ 48V
Net Weight	25.5Kg±0.8Kg
Light Dimensions	L742mm×W649mm×H438mm
Light Package Dimensions	L862mm×W812mm×H312mm

Light Distribution

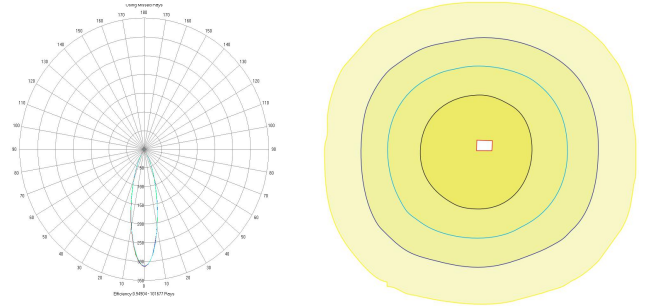

Physical Dimensions

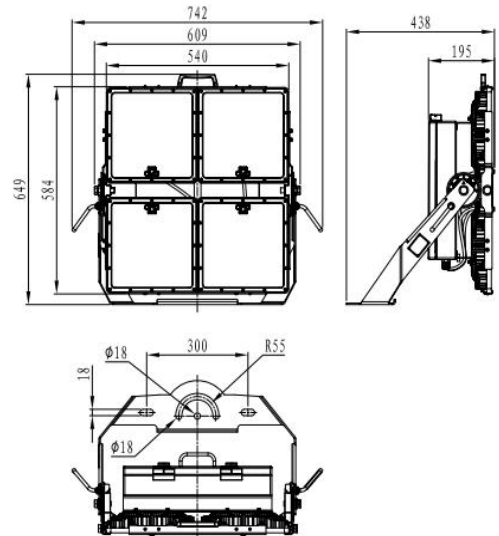

≥0.95	75 Ra	IP65	≥100000 Hrs	AC 100-277V	47-63Hz
Power Factor	CRI	IP Level	TM-21(L70)	Input Voltage	Power Frequency

Others

Power Efficiency	Working Temperature (Environment)	Heat Sink Surface Temperature
≥93%	-40°C ~ +45°C	65.5°C (Room Temperature 29°C)
Fixture Efficiency	Working Humidity (Environment)	Luminaire Base Temperature
≥90%	15%~90%RH	83.9°C (Room Temperature 29°C)
Total Harmonic Distortion	Storing Condition	LED Power Consumption
≤15%	-40°C ~ +65°C	744W±20W

Suitable for Square, Intersection, Overpass bridge, Harbor, Dock, Airport, Toll station, Stadium and Other Lighting Purposes