

Edge

60W LED street light Specification



Parameters

Product Model	YHL-ST11-60
LED Chip Brand	Nichia
Light Efficiency	130lm/W
Luminous Flux	7800lm
Color Temperature	4500 ~ 5500K(2500 ~ 5500K optional)
Beam Angle	70*150° (60*140°, 65*145° optional)
Total Power Consumption	60W±5W
Output Current	1.1A (Constant Current)
Output Voltage	DC 42 ~ 48V
Net Weight	5.4kg±0.2kg
Light Dimensions	L586mm×W300mm×H117mm
Light Package Dimensions	L675mm×W390mm×H210mm

Light Distribution

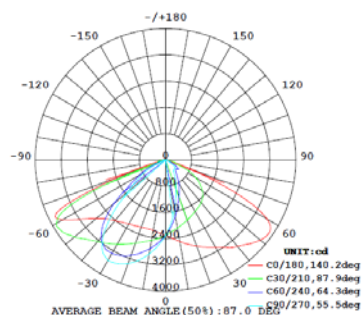

Physical Dimensions

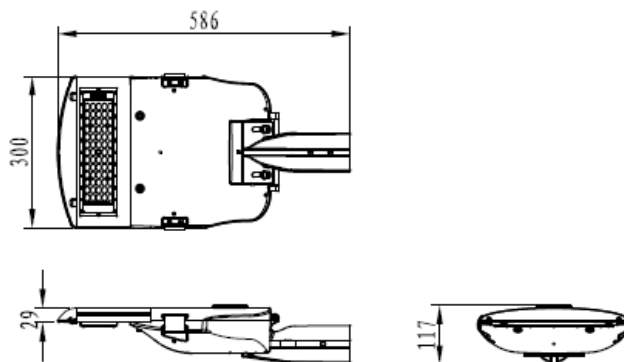

≥0.95	75 Ra	IP65	≥100000 Hrs	AC 100-277V	47-63Hz
Power Factor	CRI	IP Level	Lifespan	Input Voltage	Power Frequency

Others

Power Efficiency	Working Temperature (Environment)	Heat Sink Surface Temperature
≥90%	-40°C ~ +45°C	49°C (Room Temperature 30°C)
Fixture Efficiency	Working Humidity (Environment)	Luminaire Base Temperature
≥90%	15% ~ 90%RH	60.6°C (Room Temperature 30°C)
Total Harmonic Distortion	Storing Condition	LED Power Consumption
≤15%	-40°C ~ +65°C	53W±5W

Suitable for Highway, Roadway, Streetscape, Walkway, Parking lot, Plant road and Other Lighting Purposes

